



20 RD
20 RI

00142040-06 IM/5

IM/5a

INSTALLATION MANUAL

This manual gives detailed advice for installation and should be read carefully prior to fitting any unvented unit. Where components are supplied only for indirect units, this is clearly shown.

This OSO cylinder must be installed by a competent person and be installed in compliance with the OSO Installation and Maintenance Instructions, all current legislation, codes of practice and regulations governing the installation of unvented hot water cylinders in force at the date of installation.

Components supplied with the unit for site fitting

(See also page 2 for component list)

- * Multibloc valve, includes pressure reducing valve, line strainer, balanced cold water take off, **(for shower or bidet only)** check and expansion valve.
- * Tundish
- * 1/2" F x 15 x 15 tee piece.
- * Flexible hose.
- * 3/4" x 22mm Elbow / Drain Cock.
- * Commissioning valve, 1/2" BSP male.
- * Motorised valve (indirect only).

Components factory fitted

- * Immersion heater(s).
- * Thermostats / thermal cut-out.
- * Temperature and pressure relief valve.

Health and Safety

Manual Handling Operations Regulations 1992 defines manual handling as: "any transporting or supporting of a load (including the lifting, putting down, pushing, pulling, carrying or moving thereof) by hand or bodily force". The Regulations set no specific requirements such as weight limits. However common sense still has to be used based on an ergonomic approach for each individual.

DIMENSION AND WEIGHTS TABLE 1

PRODUCT REF.	100	125	170	210	250	330
HEIGHT	720	900	1150	1400	1600	2090
DIAMETER	580	580	580	580	580	580
WEIGHT EMPTY	34	40	48	60	64	82
MAX WEIGHT FULL	132	163	215	261	303	397

Installation details

The OSO unvented unit is designed for use with supply pressure up to 16 bar. For pressures over 16 bar an additional pressure reducing valve must be fitted in the supply pipe to the unit.

Wall mounting brackets are available for OSO unvented units 100-210 litres capacity.

General Layout Fig:1

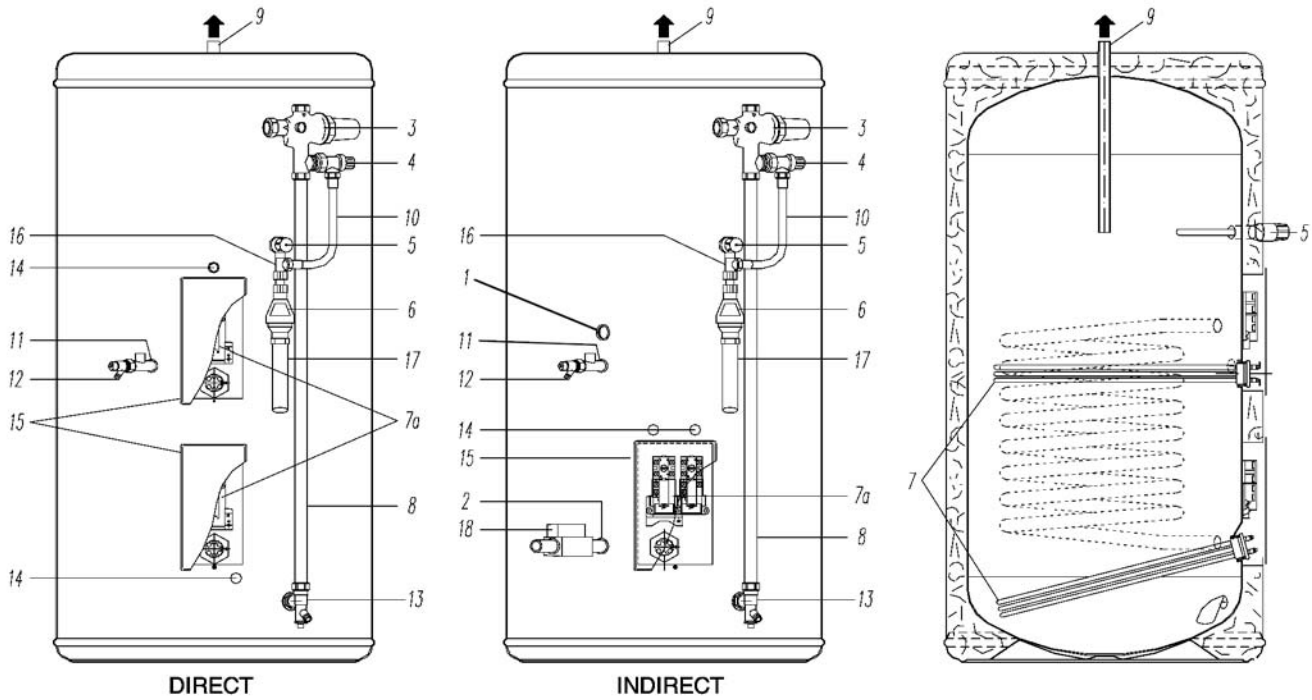

KEY		Part No	KEY		Part No
1	Return 3/4" BSPF*		10	Flexible Hose	202108
2	Flow 3/4" BSPF*		11	Secondary Return 1/2" BSPF Fit 1/2"Fx1/2"Mx15mm Tee piece (Not supplied)	
3	Pressure Reducing Valve includes item 4	510503	12	Commissioning Valve / Fitting 1/2" MI Drain Cock	250440
4	Check and Expansion Valve	510505	13	Elbow / Drain Cock	250445
5	Temperature and Pressure Relief Valve	550803	14	Cable Entry	
6	Tundish	219002	15	Electrical Box	
7	Immersion Heater	71255	16	Tee Piece	250006
7A	Thermostat Immersion Heater Thermostat Cylinder	80020 80030	17	Discharge Pipe (Not supplied)	
8	Cold Feed Tube (Not Supplied See Table 2)		18	Motorised Valve * (Not Factory Fitted)	92000
9	Hot Water Outlet 22mm		*	Indirect Only	

TABLE 2

Series	Length of tube (ø22) mm
100	480 mm
125	585 mm
170	760 mm
210	955 mm
250	1195 mm
330	1670 mm

COLD WATER SUPPLY

1. To obtain the best performance from your OSO unvented system it is advisable to feed the unit with an uninterrupted supply.
2. Locate the water heater in a suitable position to facilitate the installation of the cold water supply, discharge fittings and pipework. Also take into account access to the immersion heaters and the commissioning valve.
3. Fit the combined male elbow / drain cock to cold supply point (13), so that the compression fitting is vertical.
4. Fit the commissioning valve (12) to the commissioning fitting.
5. Fit the female outlet of the tee piece to the temperature and pressure relief valve (5) with the horizontal connection facing right at approx. 45°.
6. Fit the tundish (6) to the tee piece using a short length of 15mm copper tube.
7. Fit the length of copper tube 22mm specified in Table 2 to the cold feed elbow (see 3 above).
8. Fit the pressure reducing valve(3) to the top of the copper tube (see 7 above), so that the black knob is facing right.
9. Connect the flexible hose to the 1/2" outlet of the expansion valve (4) and the horizontal outlet of the tee piece (see 5 above). Discard compression nut & ring.
10. If a balanced mains pressure cold water supply is required to **a shower or bidet (over rim type only, ascending spray type requires type AA,AB or AD air gap)**, remove the blanking cap from the pressure reducing valve (3) and connect to the shower or bidet cold supply. ***(Major shower manufacturers advise fitting a mini expansion vessel in the balanced cold supply pipework to accommodate thermal expansion and prevent tightening of shower controls) Using the balanced cold connection to feed bath taps can reduce the flow available to the unvented cylinder.***
11. Before connecting the cold supply, flush the cold supply pipework of all flux and debris.
12. Connect the cold supply to the pressure reduction valve (Multibloc) (3).

Hot water supply

13. Connect the hot water supply pipe to the outlet (9). Ensure connection is water tight.

Secondary return

14. A secondary return facility is provided on all units. Fit a 1/2"F x 1/2"M x 15mm tee piece between the commissioning valve (12) and the commissioning fitting. See also figure 5 on page16.

Discharge pipe

15. Connect the discharge pipe from the tundish (6). This must have a continuous fall and be fitted in accordance with The Building Regulations (see pages 5 and 12).

Primary flow & return and motorised valve (Indirect only)

16. The boiler primary flow and return connections should be made to the unit. The motorised valve must be fitted into the primary flow. The primary flow and return fittings are 3/4" BSP female.
17. For electrical connection of the motorised valve and immersion heater, please read Electrical Installation Instructions. (Pages 7 - 11)

COMMISSIONING

Filling up

1. Close all hot water taps.
2. Open the commissioning valve (12).
3. Open the cold water supply valve.
4. When water flows from the commissioning valve (12), close the valve.
5. Allow system to stabilise for five minutes.
6. Open each hot water tap in turn to expel air from the system pipe work.
7. Check for leaks.
8. Manually operate Temperature and Pressure Relief Valve (5) to ensure free water flow through discharge pipe. (Turn knob to left.)

Draining

Switch the electrical power off (important to avoid damage to element). Isolate boiler from OSO unit. Turn off the cold water supply valve. Open hot water tap. Open drain (13). The unit will drain.

SAFETY AND MAINTENANCE

Safety Cut-out

1. The safety cut-out operates if:
 - a. Wiring is incorrect.
 - b. The immersion heater thermostat or cylinder thermostat fails.
 - c. Thermostat is set too high.
2. Remember before resetting the safety cut-out or altering the thermostat setting, isolate electrical supply to the unit prior to removal of the electrical box lid.
3. Reduce thermostat setting and press the reset button. After adjustments are completed, ensure the lid to the electrical box is replaced correctly and the retaining screw is fitted.
4. If still out of operation, contact installer.

Cold or tepid water discharge from tundish

1. Turn off the electrical supply to the immersion heaters.
2. Turn off cold water supply valve.
3. Open a hot tap.
4. Drain water from commissioning valve (12) until water flow stops.
5. Turn the knob on the Temperature and Pressure Relief Valve (5) to the left and hold in this position until water flow stops from the commissioning valve.
6. Close commissioning valve.
7. Close all hot taps.
8. Open cold water supply valve.
9. Turn on electrical supply to the immersion heaters.

Hot water discharge from tundish

This indicates a malfunction of a thermal cut-out, operating thermostat or the combined temperature and pressure relief valve. Turn off the electrical supply to the immersion heater and also isolate an indirect unit from the boiler. Contact the installer or competent engineer.

INSTALLATION AND SERVICING INSTRUCTIONS

Cold water inlet control (Multibloc) See Page 2 Items 3 - 4

This combination consists of a pressure reducing valve with integral strainer, check valve and expansion valve with stainless steel seat. The pressure settings are set and locked in the factory and are shown on the top of each valve. For optimum performance the following installation instructions should be complied with.

Installation

1. Cold water supply to be 22mm nominal size.
2. Flush supply pipework before connection to remove all flux and debris prior to fitting the inlet controls. Failure to do this may result in irreparable damage to the controls and will invalidate the warranty.
3. The "MULTIBLOC" can be fitted in any orientation to suit the installations long as it is fitted in the correct flow direction. Check the flow arrows on the side of the body.
4. The expansion valve should be either horizontal or upright - if fitted inverted, debris may be deposited on the seat and cause fouling of the seat when the valve operates. Check direction of flow arrows.
5. The black plastic plugs in the body are pressure gauge connections to enable pressure monitoring to be carried out, should the system develop a fault. It is recommended that these be accessible (the pressure reducing valve has two - only one need be accessible).
6. Expansion relief drain pipework must be connected to a safe visible discharge point via a tundish and the pipework must have a continuous fall.
7. The pressure reducing valve has two outlets, the second one is for a balanced cold water supply, to a shower or a bidet (**over rim type only, ascending spray type requires type AA, AB or AD air gap**) (*Major shower manufacturers advise fitting a mini expansion vessel in the balanced cold supply pipework to accommodate thermal expansion and prevent tightening of shower controls*). **Using the balanced cold connection to feed bath taps can reduce the flow available to the unvented cylinder.** The balanced cold supply is blanked off.
8. If an expansion vessel is to be fitted it must be connected to the cold feed pipe between the pressure reduction valve, (Multibloc) (3) and the cylinder.

NOTE: If the unit has been commissioned and is to be unused for more than 8 weeks it is advisable to turn off the cold supply and draw off approximately 5 litres of water through a hot tap. NB The cold supply must be opened prior to use.

The Benchmark Log Book enclosed with the cylinder should be completed after commissioning the system and handed to the customer for future reference.

MAINTENANCE

Under normal circumstances the “MULTIBLOC” combination control valve should not require any maintenance. However, annual inspection and / or cleaning of the integral line strainer, pressure reducing valve, cartridge, expansion relief valve cartridge and seating may be necessary depending on local water conditions.

Pressure Reducing Valve

1. Isolate cold water supply.
2. Unscrew the retaining nut of the valve.
The complete operating mechanism, including the strainer can be removed.
3. Clean the filter mesh and the cartridge under running water.
4. Replace cartridge ensuring that strainer is correctly located and reassemble the unit.
Pressure Reducing Valve cartridge and strainer Part No. 510 501 2.1 Bar.

Expansion relief cartridge

1. Isolate cold water supply.
2. Unscrew blue expansion relief headwork from valve body.
3. Clean valve seat face and seating - do not scratch or damage either seat face or seating.
4. Refit in reverse order. Do not overtighten Expansion valve cartridge and seat Part No. 214009 8.0 Bar. Complete Expansion Valve Part No. 510 505 8.0 Bar.

Spare Parts



Pressure reducing valve
Cartridge and strainer
Part No. 510 501
2.1 Bar



Expansion valve
(Cartridge)
Part No.
8.0 Bar 214009
6.0 Bar 214005
4.0 Bar 214046

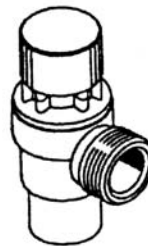

Expansion valve
Part No. 510 505
8.0 Bar

Tundish

Install the tundish in a vertical position within a maximum of 500mm from the Temperature and Pressure Relief Valve drain connection. Ensure the expansion relief pipework discharges through the tundish. Tundish pipework must be 22mm with a minimum vertical length of 300mm below the tundish. Maximum permitted length of 22mm pipework is 9 m. Each bend or elbow is equivalent to 0.8m of pipework.

All pipework must have continuous fall and discharge in a safe, visible position. If any doubt, refer to *Building Regulation G3*.

Immersion heaters

All indirect units are fitted with one immersion heater which is located behind the electrical box. With the exception of the 100 litre all direct units have two immersion heaters.

Direct Units

Wiring instructions for the immersion heaters are located on the reverse side of the lid. Follow the wiring instructions connecting the live, neutral and earth as indicated. The electrical connection to the immersion heater must conform to current IEE wiring regulations. The unit must be permanently connected to the electrical supply through a double-pole linked switch with a minimum break capacity of 13 amps. All internal wiring is factory mounted. Each immersion heater has a working thermostat adjustable between 45°C - 75°C. A safety cut-out is also incorporated within the thermostat and will operate at 85°C ± 3°C. Should this happen, press the reset button.

Important: Before resetting the safety cut-out or altering the thermostat setting, isolate electrical supply to the unit prior to removal of the lid. Ensure the lid to the electrical box is replaced correctly and the retaining screw is fitted.

The lower immersion heater should be connected to the off peak supply (if available) whilst the top immersion heater can be connected to the day tariff. The immersion heater can be connected to the mains supply through a water heater controller (Contact your local electricity company if in doubt).

Indirect Units

Motorised valve

To comply with regulations governing the installation of indirect unvented cylinders, a motorised valve must be fitted in the primary flow. Your OSO unit has been supplied with a two port motorised valve, which will act as a positive energy cut-out should the safety cut-out operate. The motorised valve will also control the temperature of the domestic stored water via the cylinder thermostat, which is located in the electrical box. The unit should be installed on an "S" or "Y" plan system. **Please follow the instructions carefully.** All electrical connections must conform to current IEE wiring regulations. The working thermostat which controls the temperature of the domestic hot water (see fig. 2) is adjustable between 45°C - 75°C. A safety cut-out is also incorporated within the thermostat and will operate at 85°C ± 3°C. Should the safety cut-out be brought into operation, the motorised valve will operate and close down the primary flow to the cylinder. To reset the safety cut-out and the motorised valve the reset button must be pressed in (see fig. 2). If using a 6-wire 28mm or 1" BSP V4043H on either circuit the white wire is not needed and must be made electrically safe.

OSO Hotwater (UK) Limited can not be responsible if alternative wiring plans are used.

Important: Before resetting the safety cut-out or altering the thermostat setting isolate electrical supply to the unit before removal of the lid.

S Plan Wiring Layout

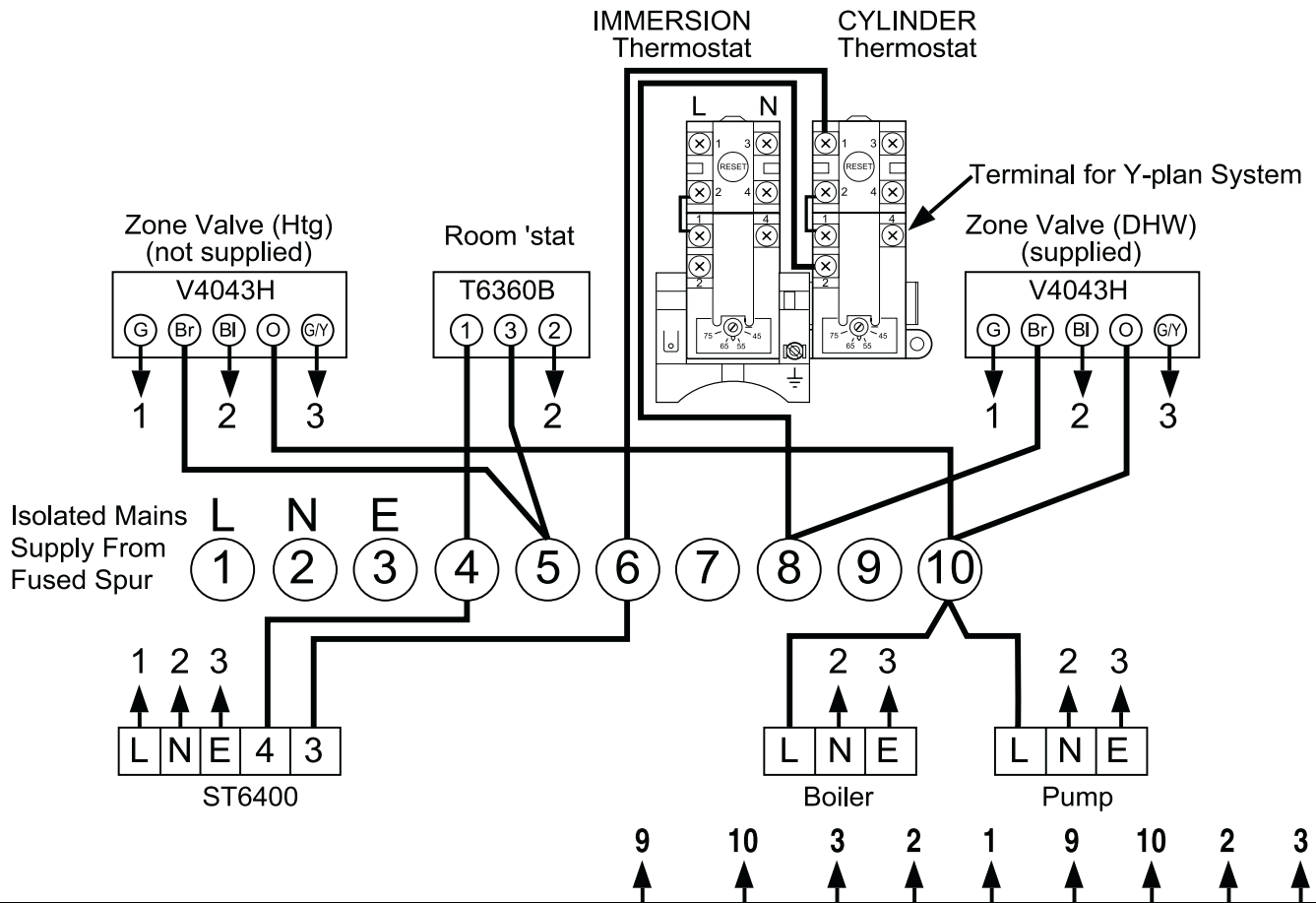

		9	10	3	2	1	9	10	2	3	
		BOILER					PUMP				
Basic Boiler		L	E	N			L	N	E		
Baxi Solo 2 30PF to 80PF and 30RS to 60RS	PL	SWL	E	N	L	L		N	E		
Ferrol Sigma	L(P)	SWL	E	N	L	L		N	E		
Glowworm Economy Plus (Remove link SL-9)	L(P)	SL	E	N	L	L		N	E		
Glowworm Energysaver (Remove link SL-1)	L(P)	SL	E	N	L	L		N	E		
Glowworm Ultimate Range (Remove link SL-9)	L(P)	SL	E	N	L	L		N	E		
Halstead Best Range	2	1	E	N	L	L		N	E		
Potterton Envoy Range	Pump	SWL	E	N	L	L		N	E		
Potterton Osprey	PL	SWL	E	N	L	L		N	E		
Potterton Profile Range	L(P)	SWL	E	N	L	L		N	E		
Potterton Suprema Range	L(P)	SWL	E	N	L	L		N	E		
Ravenheat CSI Primary	L(P)	D	E	N	L	L		N	E		
240V SYSTEM BOILERS											
Ferrol Tempra		5	E	N	L						
Glowworm System Micron 30-50		L	E	N							
Glowworm System Micron 60-80		LS	E	N	L						
Ideal systemiser SE		1	E	N	3(L)						
Potterton Suprema System		SWL	E	N	L						
Ravenheat CSI System	Refer to installation instruction										
Vokera Mynute SE Range		3	E	N	L						
For Other Boilers Refer To Boiler Manufacturer											

The wiring plan shown is based on the use of a 10-way Junction Box (Honeywell Part no. 42002116-001)
 Junction Box terminal 10 is switched live and, if needed, terminal 9 is pump live.

S Plan System Schematic

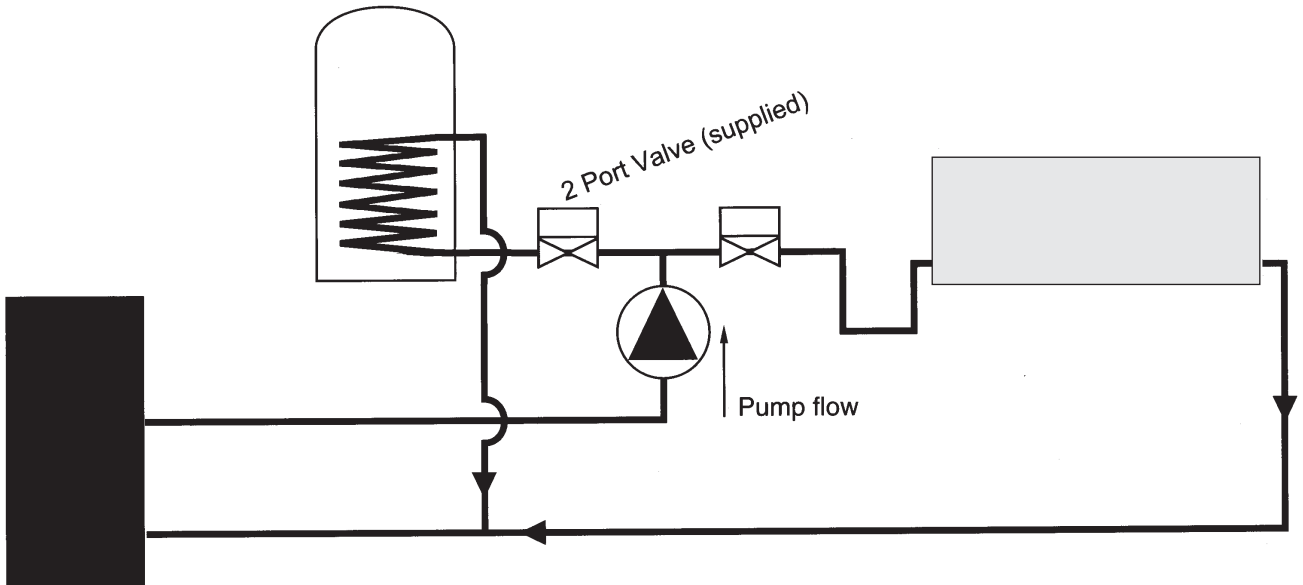

If using a 6-wire 28mm or 1" BSP V4043H on either circuit the white wire is not needed and must be made electrically safe.

Honeywell
ST 6400

Programmer 7 day

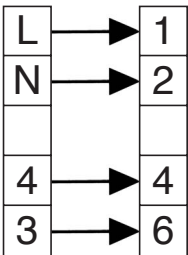

Mains

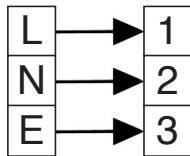

Honeywell
ST 6300

Programmer 24 Hr

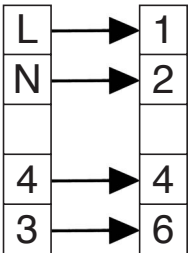

HTG Valve
V4043H

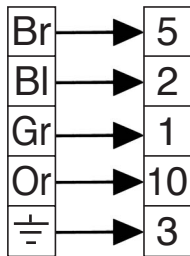

ST 6300

Room stat

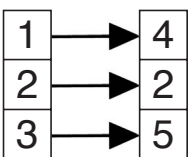

DHW Valve
V4043H

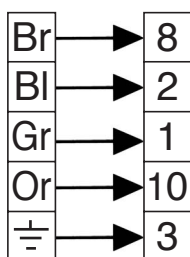
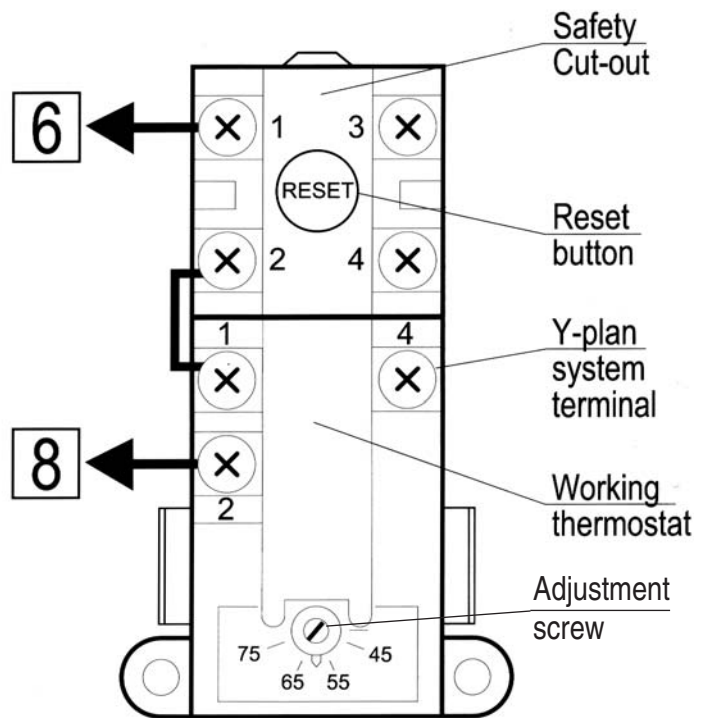

FIGURE 2



Cylinder thermostat located in electrical box

Electrical spare parts:

Direct units		Indirect units	
Thermostat	00080020	Right thermostat	00080030
		Left thermostat	00080020
Immersion heater	00071255	Immersion heater	00071255

Y Plan Wiring Layout

A Honeywell 10 way junction box must be used in a Y plan system. No other wiring centre is acceptable.

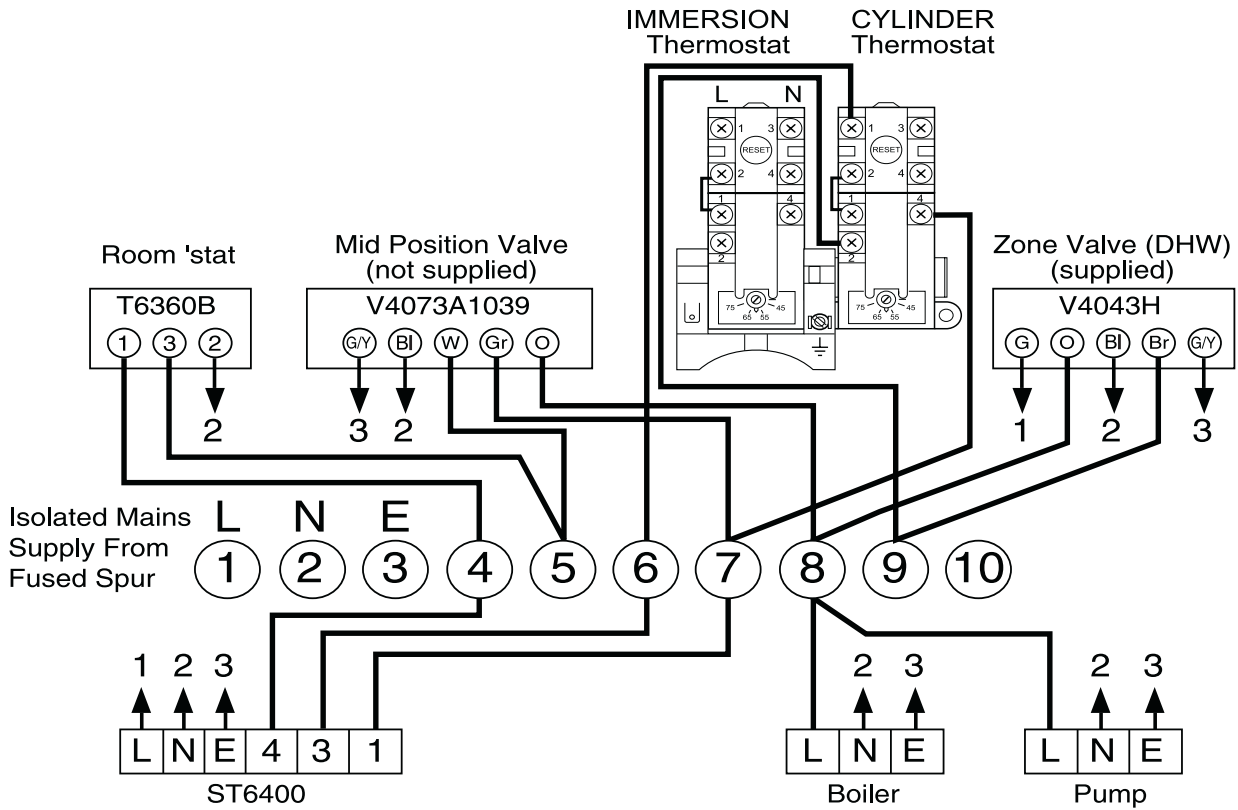

		BOILER				PUMP			
Basic Boiler		L	E	N	L	L	N	E	
Baxi Solo 2/3 PF/RS	PL	SWL	E	N	L	L	N	E	
Ferrolli Sigma	L(P)	SWL	E	N	L	L	N	E	
Glowworm Economy Plus (Remove link SL-9)	L(P)	SL	E	N	L	L	N	E	
Glowworm Energysaver (Remove link SL-1)	L(P)	SL	E	N	L	L	N	E	
Glowworm Ultimate Range (Remove link SL-9)	L(P)	SL	E	N	L	L	N	E	
Halstead Best Range	2	1	E	N	L	L	N	E	
Potterton Envoy Range	Pump	SWL	E	N	L	L	N	E	
Potterton Osprey	PL	SWL	E	N	L	L	N	E	
Potterton Profile Range	L(P)	SWL	E	N	L	L	N	E	
Potterton Suprima Range	L(P)	SWL	E	N	L	L	N	E	
Ravenheat CSI Primary	L(P)	D	E	N	L	L	N	E	

240V SYSTEM BOILERS

Ferrolli Tempra		5	E	N	L	
Glowworm System Micron 30-50		L	E	N		
Glowworm System Micron 60-80		LS	E	N	L	
Ideal systemiser SE		1	E	N	3(L)	
Potterton Suprima System		SWL	E	N	L	
Ravenheat CSI System	Refer to installation instruction					
Vokera Mynute SE Range		3	E	N	L	

For Other Boilers Refer To Boiler Manufacturer

The wiring plan shown is based on the use of a 10-way Junction Box (Honeywell Part no. 42002116-001)
Junction Box terminal 8 is switched live and, if needed, terminal 10 is pump live.

Y Plan System Schematic

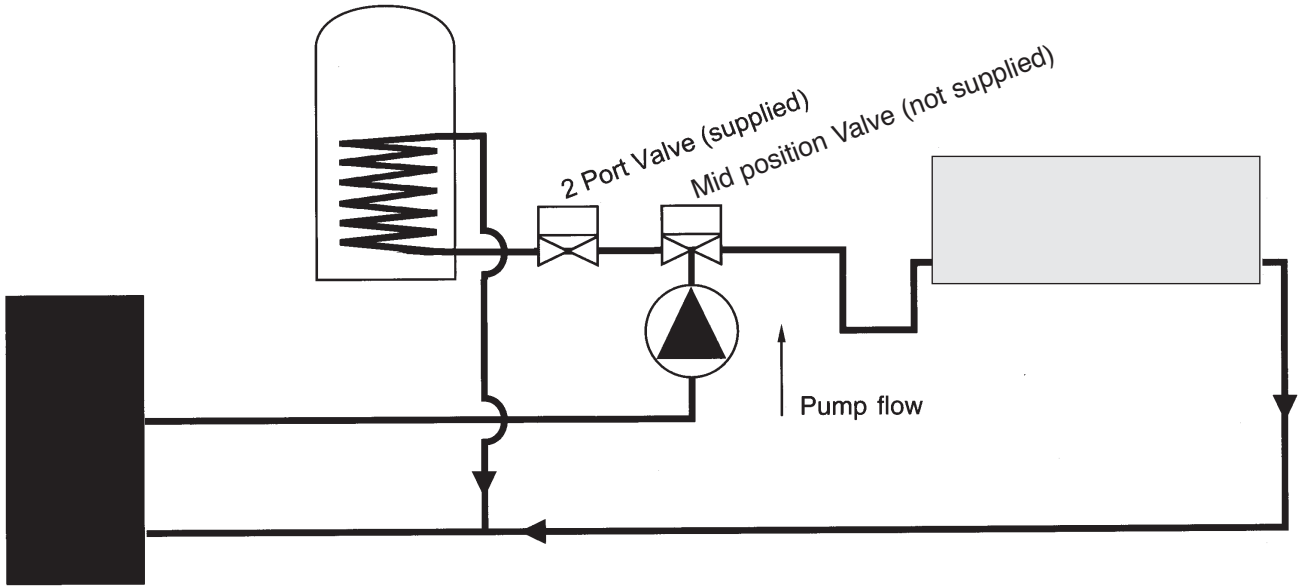

If using a 6-wire 28mm or 1" BSP V4043H on either circuit the white wire is not needed and must be made electrically safe.

Honeywell
ST 6400
Programmer 7 day

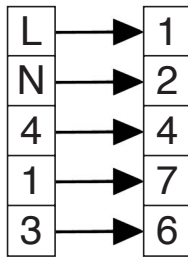

Mains

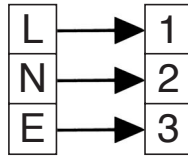

Honeywell
ST 6300
Programmer 24Hr

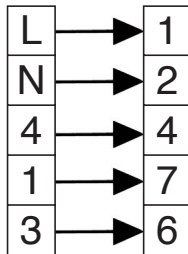

V4073A1039

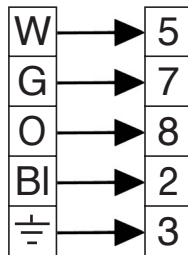

ST 6300
Room stat

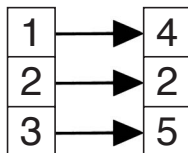

DHW Valve
V4043H

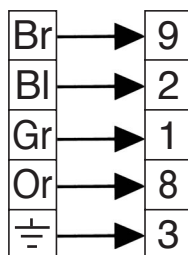

OSO FAULT FINDING GUIDE

FAULT	POSSIBLE CAUSE	REMEDY
No water flow from hot taps	<ol style="list-style-type: none"> 1. Mains supply off. 2. Strainer blocked. 3. Cold water inlet Pressure Reducing Valve incorrectly fitted. 	<ol style="list-style-type: none"> 1. Check and open stopcock 2. Turn off water supply. Remove strainer and clean. (See Pressure Reducing Valve page 6 Installation Manual) 3. Check and refit as required, (see item 3 page 5 of installation manual).
Water from hot taps is cold.	<ol style="list-style-type: none"> 1. Immersion heaters not switched on. 2. Immersion heater thermal cut-out has operated. 3. Programmer set to central heating or not switched on. 4. Boiler not working. 5. Cylinder thermal cut-out has operated. (Indirect units only). 6. Motorised valve not operating correctly. 	<ol style="list-style-type: none"> 1. Check and switch on. 2. Check and reset button. (See thermostat diagram page 9 and safety cut-out on page 4 of installation manual). 3. Check and set to hot water. 4. Check boiler operation. If fault suspected consult installer or boiler manufacturer. 5. As at No. 2. 6. Check wiring and / or plumbing connections to motorised valve. (See pages 8 or 10 of the installation manual).
Intermittent water discharge.	<ol style="list-style-type: none"> 1. Reduced internal expansion. 2. Thermal control failure. (Note Water will be hot). 	<ol style="list-style-type: none"> 1. Recharge "air gap" (See cold water discharge on page 4 of installation manual). 2. Switch off power to immersion heater(s) and boiler supply to the unit. When discharge has stopped, check thermal controls, replace if faulty. Contact a competent person.
Continuous water discharge.	<ol style="list-style-type: none"> 1. Cold water inlet Pressure Reducing Valve not working. 2. Temperature and pressure relief valve faulty. 3. Expansion relief valve not working correctly. 	<ol style="list-style-type: none"> 1. Check pressure from valve if greater than 2.1 bar replace. (See page 6 of installation manual). 2. As No. 2 of above. 3. Check and replace if faulty. (See page 6 of installation manual).

NOTE: Disconnect electrical supply before removing any electrical equipment covers

OSO FAULT FINDING GUIDE

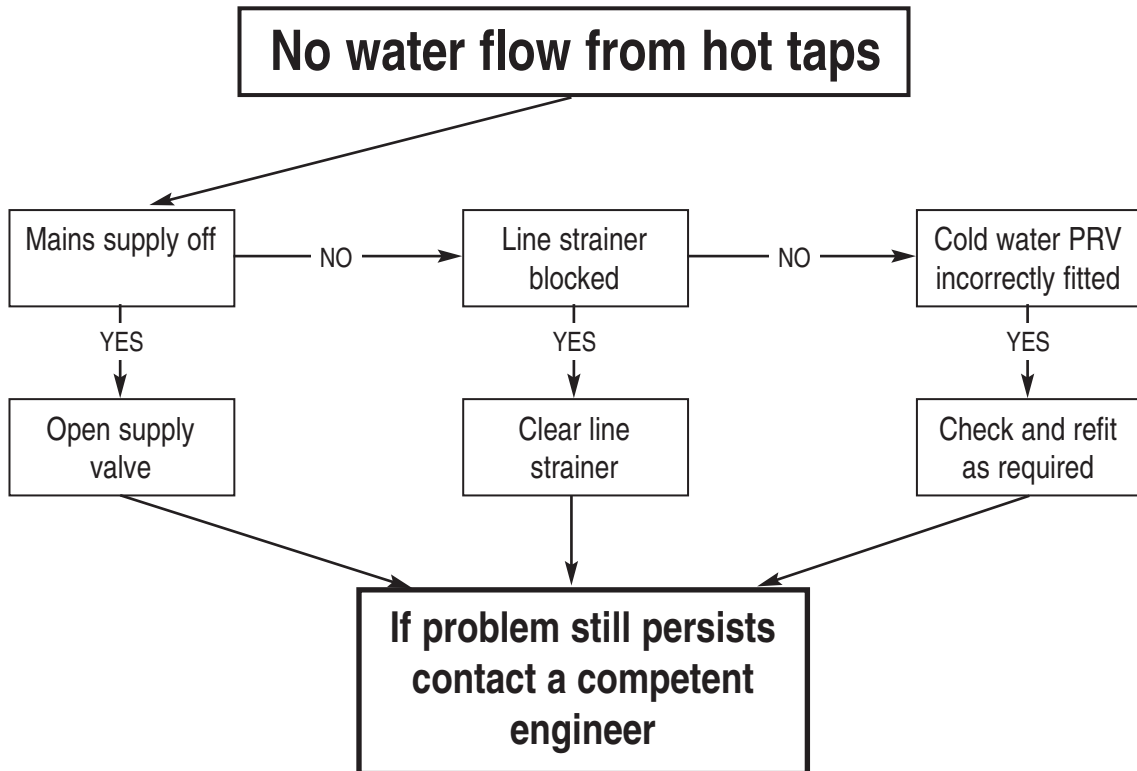

OSO FAULT FINDING GUIDE

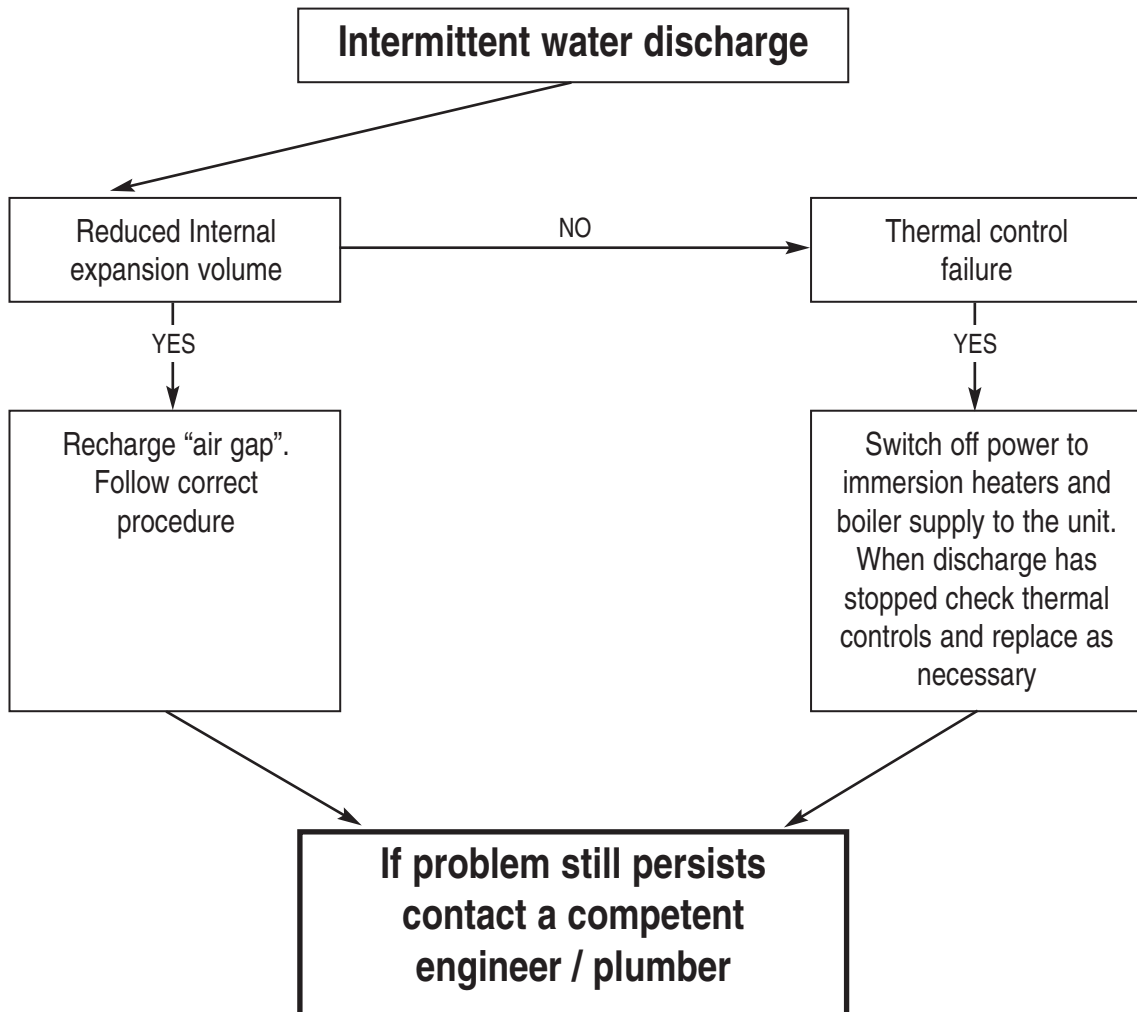

OSO FAULT FINDING GUIDE

Hot water from taps is cold

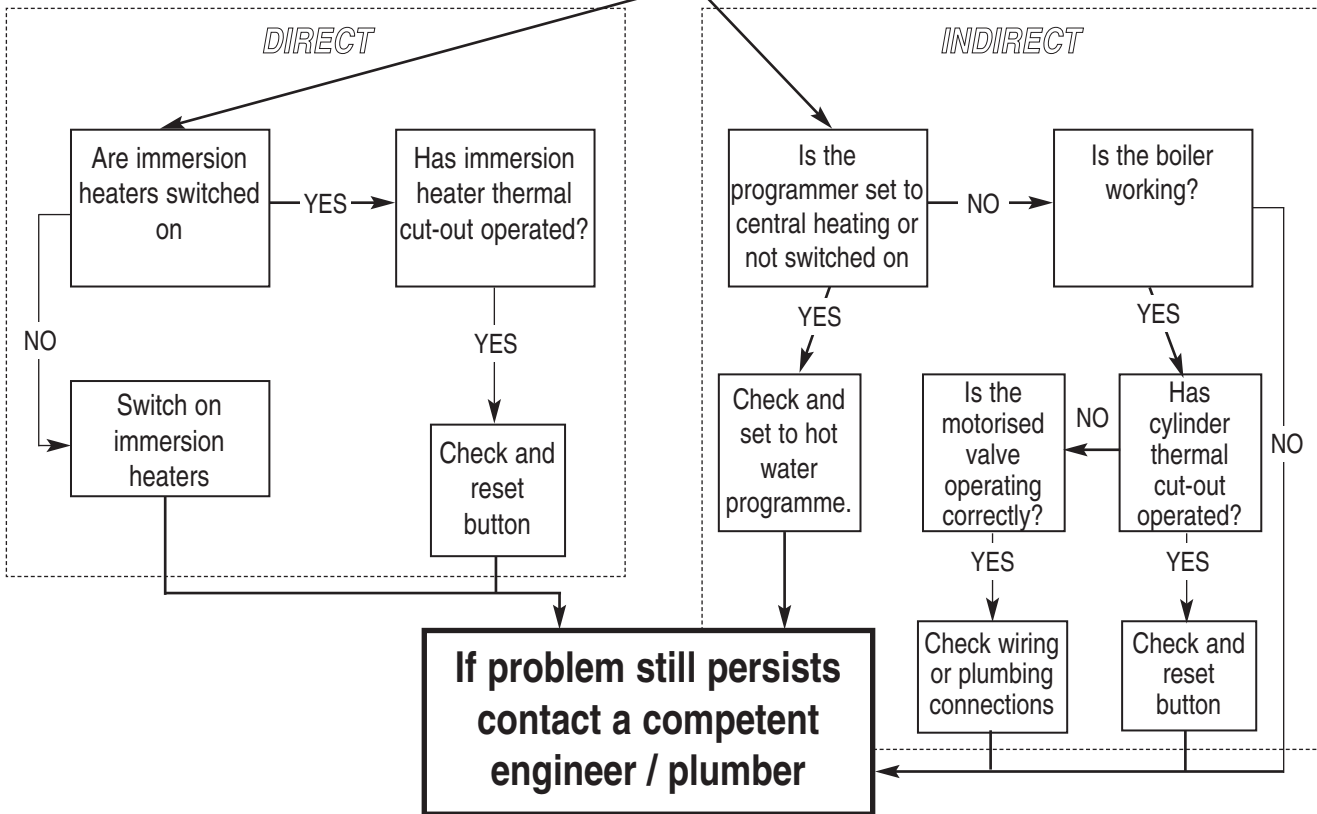

Excessive Hot water from taps

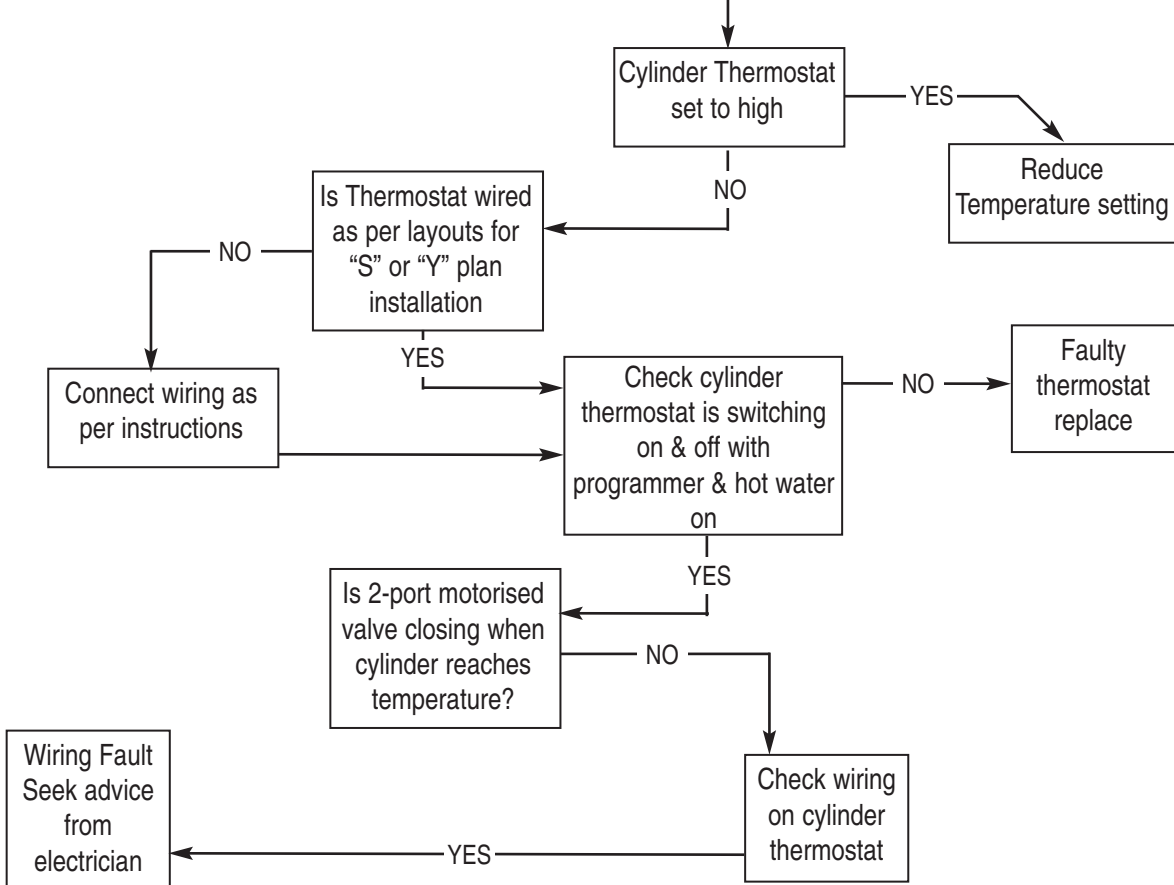

If in doubt at any stage you must consult a qualified electrician

INCREASED VOLUMES AND HIGH PRESSURE OPERATION

1. The capacity of all OSO cylinders can be increased by approximately 20% if the internal hotwater dip pipe supply connection is removed. To accommodate the expansion of secondary water an expansion vessel suitable for potable water must be connected to the cold entry to the cylinder (See fig. 3).
2. Increased pressures can be obtained by fitting an adjustable pressure reducing cartridge (part no. 510504) in the pressure reducing valve. This cartridge is adjustable between 0.5 - 5.0 bar. It is advisable to remove the hot supply connection and fit a suitable expansion vessel. (see 1 above) (see fig 3)
3. Table 3 gives details of cylinder and expansion vessel capacities for a range of pressure settings.
4. The expansion vessel must be suitable for potable water and charged to the same pressure as the pressure reducing valve.
5. If the internal hot supply dip pipe connection is removed it is preferable to fit a replacement cartridge in the expansion relief valve. This can be obtained from OSO Hotwater UK.

Pressure Reducing Valve
Setting Bar

Expansion Relief Valve
Setting Bar (Part No)

0.5 - 2.5

4 214046

2.6 - 3.9

6 214005

4.0 - 5.0

8 (no change)

Standard Capacity		100	125	170	210	250	330
Without Dip Pipe		120	150	200	250	300	380
PRV Bar	Expansion Relief Bar	Expansion Vessel Volume (Litres)					
2	4	12	12	18	25	25	40
2.5	4	12	18	25	25	40	40
3	6	12	12	18	18	25	40
4	8	12	12	18	18	25	40
5	8	12	18	18	25	40	40

FIGURE 3

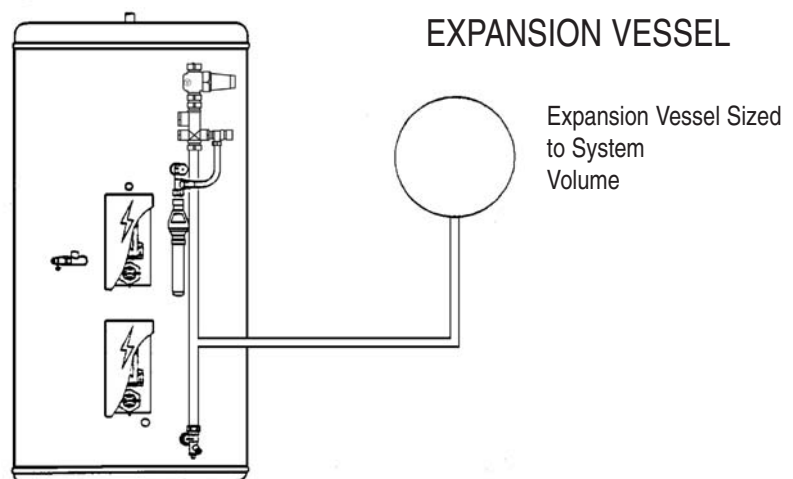

ALTERNATIVE DISCHARGE

Downward discharges at low level, i.e. up to 100mm above external surfaces such as car parks, hard standings, grassed areas etc, are acceptable providing that where children may play or otherwise come into contact with discharges, a wire cage or similar guard is positioned to prevent contact, whilst maintaining visibility.

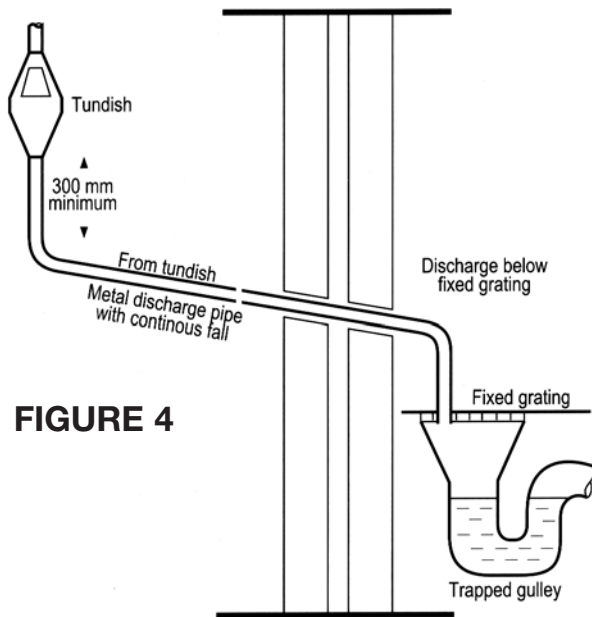

FIGURE 4

Discharge at high level, i.e. into a metal hopper and metal down pipe with the end of the discharge pipe clearly visible (tundish visible or not) or onto a roof capable of withstanding high temperature discharges of water and 3m from any plastics guttering system that would collect such discharges (tundish visible).

Where a single pipe serves a number of discharges, such as in blocks of flats, the number served should be limited to not more than 6 systems so that any installation discharging can be traced reasonably easily. The single common discharge pipe should be at least one pipe size larger than the largest individual discharge pipe to be connected. For further information contact your Building Control Office or The British Board of Agrément.

SECONDARY RETURN

FIGURE 5

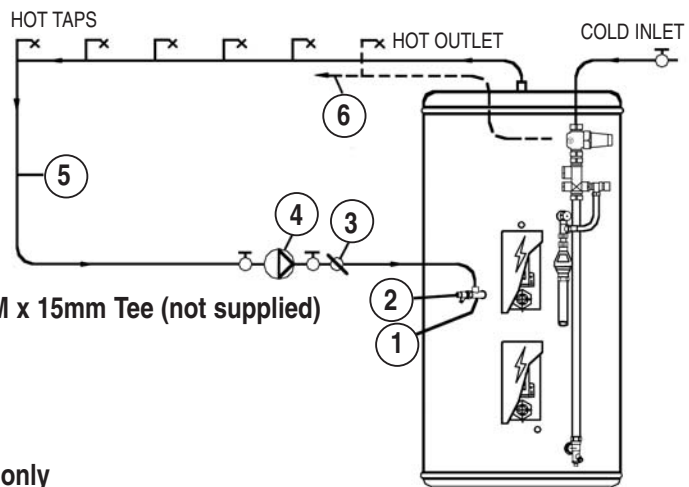

- 1 Secondary Return Fitting use 1/2" F x 1/2" M x 15mm Tee (not supplied)
- 2 Commissioning Valve
- 3 Non Return Valve
- 4 Circulation Pump
- 5 Secondary Return Line
- 6 Balanced cold supply for showers or bidet only

All replacement parts must be supplied by OSO HOTWATER (UK) LIMITED.

To obtain the address of a local stockist contact:

OSO HOTWATER (UK) LTD
E15 Marquis Court
Team Valley Trading Estate
Gateshead
Tyne & Wear, NE11 0RU

www.oso-hotwater.com

E-mail technical.uk@oso-hotwater.com

Phone: (0191) 482 0800
Fax: (0191) 491 3655

E-mail spareparts.uk@oso-hotwater.com
E-mail sales.uk@oso-hotwater.com